

Roc

CAAS Architetti
2012

Dimensioni cm

Materiale: Panchina in cemento colorato in massa.

Peso: Panca Roc 2.700kg. / Fioriera Roc 950kg. / Sedile Roc 350kg.

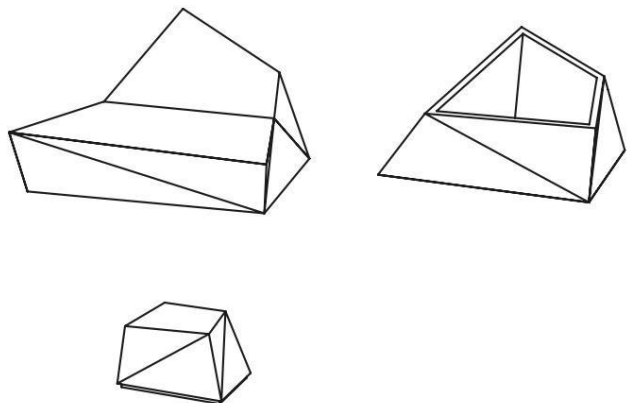

ROC BENCH

ROC PLANTER

ROC SEAT

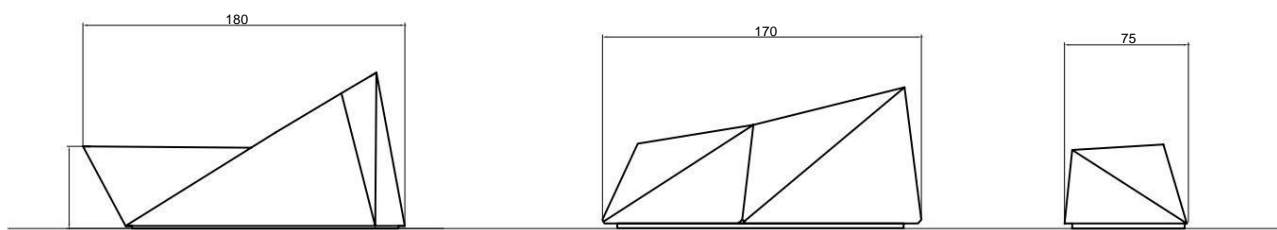

Sistema di posizionamento

Movimentazione con imbracature lunghe in poliester.

Appoggiato a terra.

Roc Seat ha un bullone filettato nella base, in caso sia necessario un fissaggio aggiuntivo.

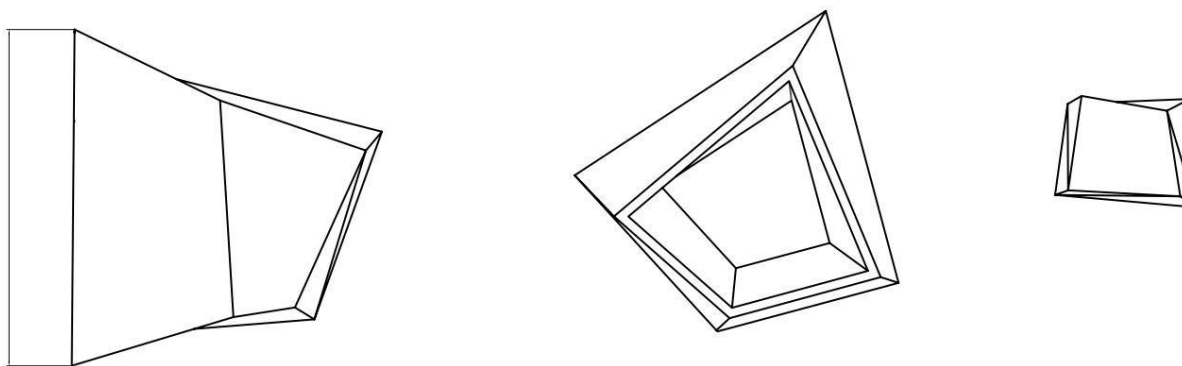
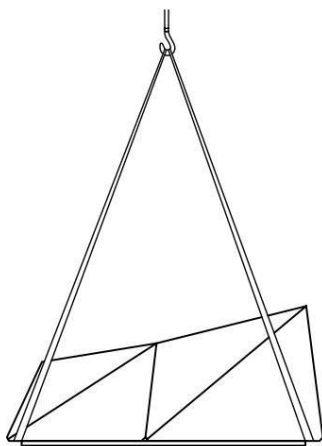

Roc

CAAS Architetti
2012

Dimensioni cm

Materiale: Panchina in cemento colorato in massa.

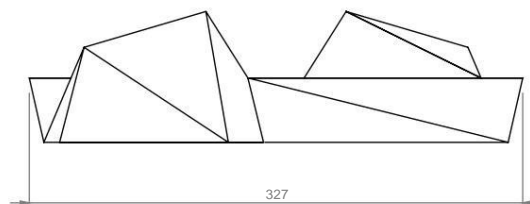
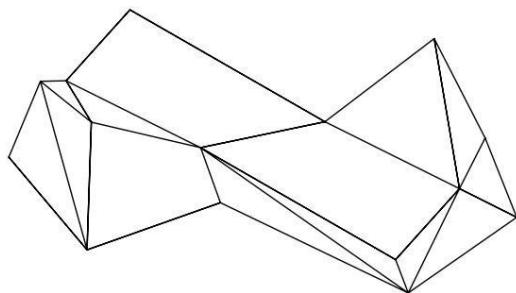

ROC ASSEMBLY

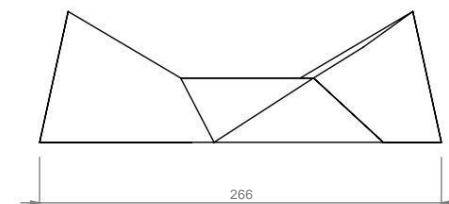

Sistema di posizionamento

Movimentazione con imbracature lunghe in poliester.

Appoggiato a terra.

Roc Seat ha un bullone filettato nella base, in caso sia necessario un fissaggio aggiuntivo.

